

TERMS AND CONDITIONS OF OPERATION OF
SEWAGE PUMPING,
GREASE PUMPING,
AND TOILET RENTAL AGENCIES
IN KERN COUNTY



2700 "M" Street, Suite 300

Bakersfield, CA 93301

Office: (661)862-8740

Fax: (661)862-8701

E-Mail: eh@co.kern.ca.us

<http://kernpublichealth.com/>

[solid-waste/](#)

Revised February 5, 2016

TABLE OF CONTENTS

Introduction	3
Disease Hazards of Sewage	4
Proof of Knowledge by Examination	5
Disposal and Interim Storage of Waste	5
Quick Reference for New Vehicles	6
Minimum Requirements For All Vehicles	7
Portable Chemical Toilet Requirements	8
Maintenance Yard/Storage Facility Requirements	8
Grease Pumpers and AB 1333	9
Documenting and Reporting	9
Special Conditions	14
Enforcement	15

Introduction

- According to the **California Health and Safety Code, Section 117400 et seq.**, those who wish to enter into the business of sewage pumping or the rental of portable toilets, or both, must register their business with the local Health Officer of that city, town, or county in which is desires to conduct this activity.
- Pursuant to **Section 19310 of the Food and Agricultural Code**, grease haulers are required to register with the California Food and Agriculture Department.
- Likewise, **Kern County Ordinance Code 8.04.030** requires that those who desire to conduct these same businesses within Kern County “shall apply for an environmental health permit on the form provided, pay to the health officer the prescribed fee and penalty, if any, and shall at all times possess said permit.”
- The Kern County Public Health Services Department, Environmental Health Division (KCEHD) has the enforcement authority to register, issue environmental health permits, and regulate the activities of sewage pumping, grease trap pumping and toilet rental businesses.
- The following information and application reflects the Terms and Conditions of Registration individuals and businesses conducting sewage pumping, grease trap pumping and/or toilet rental businesses agree to follow. In so doing they will comply with both state law and the policies established by the Health Officer.

If there are any further questions, you may contact our office and ask to speak to a Solid Waste Specialist.

Kern County Public Health Services Department, Environmental Health Division

Office: (661) 862-8740

Email: eh@co.kern.ca.us

<http://kernpublichealth.com/solid-waste/>

Disease Hazards of Sewage

Exposure to human fecal waste can occur through the following methods:

- Swallowing
- Eating with soiled hands
- Contact with flies, cockroaches, etc.
- Soft tissue around the eyes and nose
- Cuts and scratches on the skin
- Contact with hoses, hand tools, etc.
- Inhalation

Infectious diseases caused by the improper handling or disposal of sewage include:

- Dysentery
- Salmonellosis
- Hepatitis
- Typhoid fever
- Poliomyelitis (Polio)
- Paratyphoid fever
- Cholera

Sewage can also contain:

- Toxic chemicals
- Pesticides
- Heavy metals
- Parasites

Some of these materials can accumulate in the body over time, resulting in poor health or malignant (cancerous) health conditions.

It is important that those involved in the care of sewage disposal systems exhibit good sanitary practices and take precautions when handling and disposing of sewage wastes. It is recommended that sewage workers wear appropriate protective gear, including:

- Coveralls
- Rubber boots
- Non-absorbent gloves
- Eye protection.

Additionally, appropriate measures are required to protect the public health by preventing contamination of soil and water. This is done by:

- Maintaining vehicles and equipment in a clean, sanitary condition.
- Maintaining leak-proof and fly-tight vessels, tanks, pumps, hoses and holding containers reduces the incidence of accidental spillage, odors and the attraction of vectors.
- The immediate clean-up and proper disinfection of contaminated areas ensures that disease causing organisms are effectively destroyed.

Proof of Knowledge By Written Examination

California Health and Safety Code, Section 117420, the health officer shall issue a “registration” only after the applicant satisfactorily completes an examination. The test consists of twenty (20) questions, which measure the applicant’s knowledge of sanitary laws and ordinances, as well as equipment and reporting requirements within Kern County. The questions have been taken entirely from the contents of this booklet. The application package is not complete until the applicant passes the test.

Disposal and Interim Storage of Waste



All sewage, portable toilet, and grease trap wastes shall be disposed of at a municipal waste water treatment plant.



Copies of disposal permits/letters of authorization or approved “*Will Serve Letter*” issued by any treatment plant shall be submitted to KCEHD within fifteen (15) days of issuance. A “*Will Serve Letter*” is a written document which promises to provide or allow the use of their waste disposal plant upon completion of the Environmental Health Permit Registration.



Firms operating in Kern County which plan to utilize land application disposal sites require prior approval from KCEHD.



Stationary Tanks used for the interim storage of sewage before transporting to an approved disposal location require land use approval from the local authority for this activity.



Vehicles and/or tankers used for the interim storage of sewage must possess a valid health permit/registration issued by KCEHD.

GREASE PUMPING

TANK No. 0058

KERN COUNTY DEPARTMENT OF PUBLIC HEALTH SERVICES
ENVIRONMENTAL HEALTH DIVISION

SEWAGE PUMPING

TANK No. 1278

KERN COUNTY DEPARTMENT OF PUBLIC HEALTH SERVICES
ENVIRONMENTAL HEALTH DIVISION

**COUNTY OF KERN
2013-2014
ENVIRONMENTAL
HEALTH
PERMIT**
Expires June 30, 2014
CA H & S Code Registration

Lettering must be at least 3 inches high and 1/2 inch thick, legible, and in a contrasting color.

Don't forget:

Mounted and charged fire extinguisher

Shovel

Hand sanitizer

Bleach



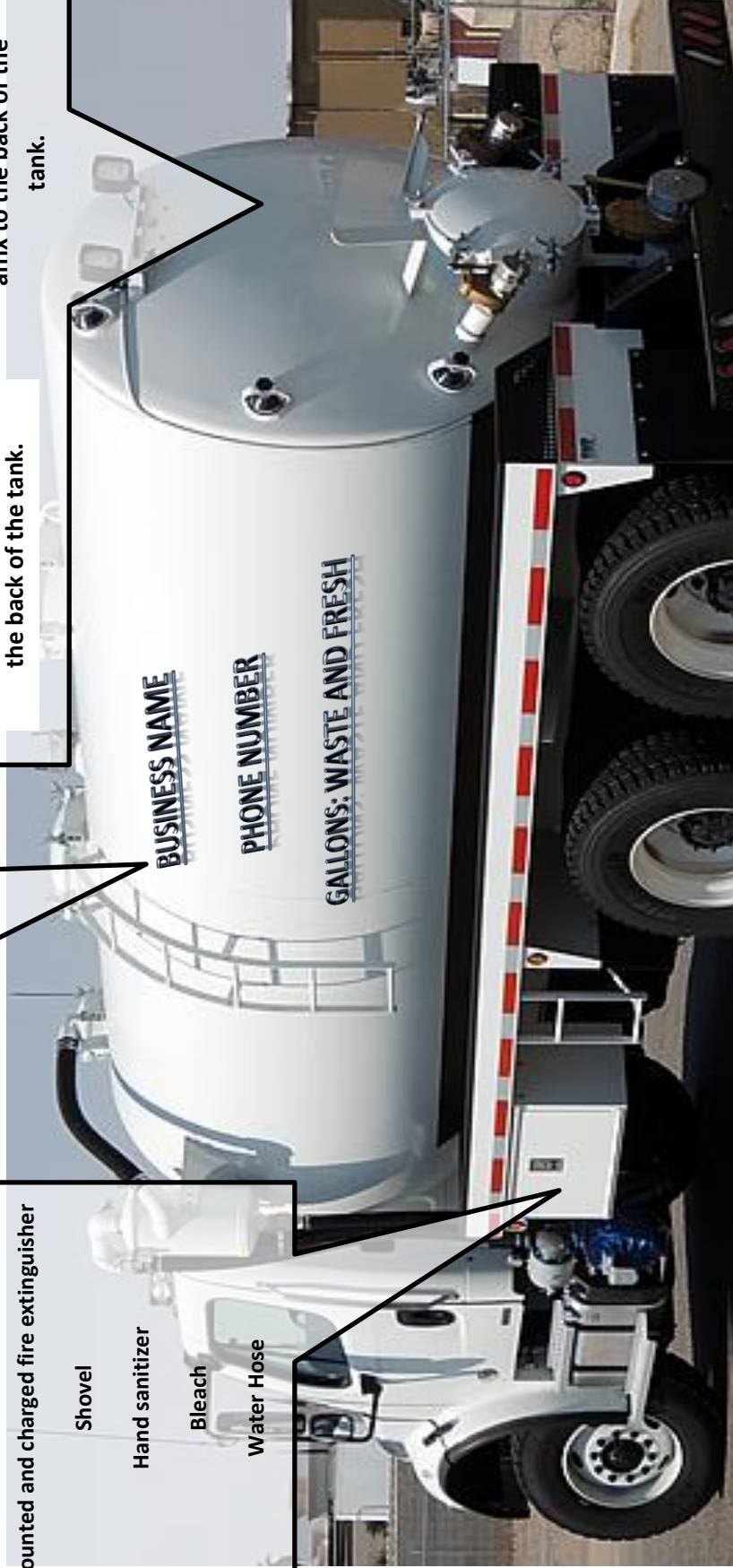

Water Hose

DECALS shall be affixed to the back of the tank.

PERMIT STICKER shall be affixed to the back of the tank.



Minimum Requirements for **ALL** Vehicles

Permits and Decals	Lettering	Equipment
<p>__1. Copy of the current health permit within the vehicle at all times.</p>	<p>__9. Business name and phone number affixed on both sides of the vehicle.*</p>	<p>__15. Racks are constructed and maintained so as to be easily cleanable.</p>
<p>__2. Current health permit registration stickers affixed to the tank.</p> 	<p>__10. Tank volume affixed on both sides of the vehicle. **</p>	<p>__16. Discharge gates or valves are constructed and maintained to prevent leakage or spillage</p>
<p>__3. Sewage/Grease pumping decals affixed to the tank.</p>  	<p>__11. Tanks with split volumes shall be so indicated on both sides of the tank. **</p>	<p>__17. Discharge gates or valves are constructed to discharge contents in a manner which will not cause pollution or create a nuisance.</p>
Tank Construction	<p>__12. Lettering a minimum of 3-inches in height and ½-inch diameter.</p>	<p>__18. Pumps are constructed and maintained to prevent leakage or spillage.</p>
<p>__4. Tank is metal, and welded or riveted.</p>		
<p>__5. Tank is watertight and splash proof.</p>	<p>__13. Lettering is distinctly contrasting from the background.</p>	<p>__19. Adequate hoses are present to properly reach sources without spilling onto the surface of the ground.</p>
<p>__6. All access ports are adequately sealed and do not leak.</p>	<p>__14. Lettering is legible during daylight hours from a distance of fifty (50) feet.</p>	<p>__20. A water hose present with a minimum 5/8-inch diameter and fifty (50) feet in length.</p>
<p>__7. The tank has an automatic shut-off valve to prevent overflow.</p>		<p>__21. A mounted and charged fire extinguisher.</p>
<p>__8. The tank is properly baffled to prevent sloshing.</p>		<p>__22. Shovel(s) in good repair.</p>
<p>*Vehicles which are able to unhitch waste tanks from the vehicle itself must permanently affix information to the tank, not only the doors of the vehicle.</p> <p>**Tank volume must be placed on the tank itself, not the door(s) of the vehicle.</p>		<p>__23. Hand cleaner and/or hand soap.</p> <p>__24. One (1) gallon of liquid bleach or other approved disinfectant for disinfecting small spills.</p>

Portable Chemical Toilet Requirements

__1. Toilets maintained clean and sanitary.	__5. Doors are self-closing and lock from the inside.	__9. Toilets have a minimum of ten (10) square feet of floor area when equipped with a urinal, and a minimum of eight (8) square feet of floor space when not equipped with a urinal.
__2. Toilets maintained free of refuse or debris.	__6. Toilets have adequate ventilation ports which are fly-screened and vector-proof.	
__3. Toilets free of ponding of septage, sewage, and/or wastewater.	__7. Toilets are constructed with smooth, nonabsorbent, and easily cleanable surfaces.	
__4. Portable chemical toilet pumping vehicles have fresh water to service toilet units.	__8. Toilets have a holding tank with a minimum of forty (40) gallons	

Maintenance Yards and Storage Facility Requirements

__1. Zoning is approved by the Kern County Planning Department or local planning authority	__4. The facility is free of ponding, pooling, standing sewage or septic waste water effluent, fecal material or grease waste on the surface of the ground.	__7. Appropriate land use approval has been granted for stationary holding tanks and containment vessels used for the temporary portable waste, sewage, and grease prior to transport for disposal.
__2. Property owner authorization to use the property for storage purposes.	__5. The facility is free of stagnant water which would provide a breeding area for mosquitos and other insects.	__8. The property is free of refuse, trash, debris, and excessive weeds.
__3. The property is free from cross connection hazards to the public water system.	__6. The operator has supplied a hazardous materials operational business plan to the local authority of the storage of hazardous materials and hazardous wastes.	

Assembly Bill 1333 and Grease Pumpers

On August 28, 2006, the Governor of California signed into Law **Assembly Bill 1333**. According to this Assembly Bill, vehicles which pump grease interceptors/traps cannot be used to pump any other waste. In Kern County, **businesses must designate vehicles for the sole purpose of pumping grease or other wastes—but the same vehicle cannot be used pump grease and other waste streams.**

In addition, this bill mandates that the entire grease trap tank shall be pumped.

Used interchangeably in some parts of the country, “traps” may refer to the small, indoor, above-grade system used to prevent kitchen grease from entering the sewer system, while “interceptors” may refer to the large, external, below-ground devices. For purposes of this Registration Pamphlet, “traps” will be used for both.

Documentation and Reporting

Record Retention



All pertinent records for the current and previous **two (2) years** shall be kept accurate and made available for inspection upon request. Pertinent records include:

1. Customer receipts;
2. Waste manifests;
3. Monthly pumping reports; and
4. Information requested in the Health and Safety Registration Application.

Mandatory Reporting



A change in company address shall be reported in writing to KCEHD by registered mail within **two (2) working days**.



Additionally, any change in the following shall be reported in writing to KCEHD **within five (5) working days**:

1. Any change in vehicle storage yard location;
2. Addition or removal of pumping vehicles;
3. Change in company ownership; and
4. Change in/addition of waste disposal locations.



All discharges, including spills exceeding five (5) gallons, in areas not intended for discharge shall be reported to KCEHD **within twenty-four (24) hours** of said discharge. Written notification shall be provided to KCEHD **within five (5) working days**. Written notification may be submitted via fax to (661) 862-8701, via mail, or via e-mail to eh@co.kern.ca.us.

Customer Records



The customer shall receive from the sewage/grease trap pumping business a written statement showing the services rendered. It is also understood that the entire septic tank/grease trap shall be pumped. The following information is required on the customer's written receipt or statement:

1. Customer name, physical address, and date of pumping service;
2. The number of compartments pumped;
3. Estimated gallons removed;
4. The type of septic containment device pumped: e.g. septic tank, cesspool, sewage well, vault, privy, restaurant grease trap, wastewater pond; and
5. Any repairs and replacement parts used.

Monthly Pumping Reports



According to the **California Health and Safety Code, Section 117435(a)**, all sewage pumping and grease trap pumping businesses shall file with the health officer, or his or her duly authorized representative, a report specifying the pumping activities over a given frequency. These reports are legal documents, and it is very important they are closely reviewed by the operator before being submitted to the Division.

1. All companies shall submit a **typed or legibly printed** pumping report of activities to this Division no later than **the 15th day of the following month.**
2. Reports are specific to pumping activities within the designated month. If a pumping activity from a previous month is omitted from that month's report, it shall not be included on the following month's report. A corrected report shall be submitted which would reflect the previously omitted activity.
3. Interim storage of sewage, portable toilet and grease trap wastes in stationary tanks, transfer, or out-of service vehicles shall be reporting in the Monthly Pumping Report.
4. If no pumping activity has occurred for the month, **"No Activity"** or **"No Pumping This Month"** shall be written on the pumping report, and submitted.

SEWAGE PUMPING REPORT

MONTHLY PUMPING REPORT

Company _____

Return to:

Report for the month of: _____

FA: _____

Kern County Environmental Health Division
2700 "M" Street, Suite 300
Kern, CA 93301

Address _____

**Include your company's full
name and address.**

Waste Types:
1=Septic
2=Grease
3=Other: Specify

RESIDENT NAME (Last, First)
OR BUSINESS NAME

ADDRESS OF JOB

CITY

DATE
PUMPED

DATE
DISPOSED

DISPOSED

WASTE
Other
Specify

TANK
DECAL #

Gallons

**The FA# is assigned to all new
companies upon registration with
Kern County Environmental Health
Division (Example: FA0001234).**

**Include the complete
business name or
residential customer name
for the property being
services. This is not a
real estate or title
company who requests the
pumping for a real estate
transaction.**

Address _____

Submit by the 15th of the following m

RESIDENT OR BUSINESS NAME
JOB COMPLETED

PHYSICAL
ADDRESS OF JOB

CITY

DATE
PUMPED

**The complete physical address of where
the pumping activity took place, including
the city. If an address is unavailable, the
use of an Assessor Parcel Number or an
intersection is sufficient.**

**When material is pumped from the same
address, the volumes pumped shall be
reported separately.**

**The date of the
pumping activity.**

TOILET RENTAL AGENCY MONTHLY REPORTING

TOILET CLEANING MONTHLY REPORT

Company _____ Return to: Kern County Environmental Health Division
Address _____ 2700 "M" Street, Suite 300 Bakersfield, CA 93301
FA _____ Office: (661) 833-5555
Month of _____ 20____

MUST BE RECEIVED BY THE 15TH OF THE FOLLOWING MONTH

DISPOSAL DATE

The FA# is assigned to all companies upon registration with Kern County Environmental Health Division (Example: FA0001234).

Include your company's full name and address.

DISPOSAL DATE	DISPOSAL LOCATION	GALLONS DISPOSED

The specific disposal location of where waste is discharged. Your company shall provide proof of authorization from the disposal facility before obtaining a Health Permit from this Division.

The completed report shall be signed by the operator or authorized representative.

I CERTIFY UNDER PENALTY OF PERJURY THAT THE FORGOING IS TRUE AND CORRECT:

OWNER/OPERATOR SIGNATURE DATE

Print name of person signing above

A report must be submitted even if pumping is not performed during the month. **If no pumping occurs for the month, write "No Pumping This Month" across the report.**

Special Conditions

Waste Streams



Sewage pumping vehicles may only be used for pumping and transporting sewage and/or chemical toilet wastes due to **AB 1333**.



Penal Code 374.5(c) prohibits grease trap pumping vehicles from transporting or removing “yellow grease, cooking grease, recyclable cooking oil, septic wastes, or fluids collected at car washes”.



Any material hauled in a sewage pumping vehicle is considered to be contaminated with sewage and therefore must be deposited at a sewage treatment plant or permitted land disposal site.



Sewage pumping vehicles may **not** be used for:

- ✓ Pumping Grease Traps
- ✓ Spreading Water
- ✓ Hauling Oilfield Waste
- ✓ Hauling Car Wash Wastes
- ✓ Hauling Other Industrial Wastes



Other waste streams must be approved in advance by the Kern County Environmental Health Division. Written notice must be received by this Division prior to approval.

California State Agency Requirements



Those pumping companies that engage in pumping grease interceptors shall also comply with the requirements of the Department of Food and Agriculture (CDFA). This includes registering with the CDFA and displaying the grease hauler registration decal.

Other Conditions



All permit fees must be paid prior to operating in Kern County. Kern County operates on a fiscal year, which commences on July 1 and ends on June 30. The purpose of the health permit fee is to cover the initial cost of vehicle and storage yard inspections, and the review of monthly pumping reports. These fees are subject to change, pending approval of the Kern County Board of Supervisors.

Enforcement

When an operator of a sewage pumping, grease pumping, or toilet rental business is found in violation with the terms and conditions of the Health and Safety Registration, KCEHD may initiate enforcement action. Methods of enforcement action include:



Kern County Ordinance Code 8.04.190 (B): Failure to obtain or possess an Environmental Health Permit as required is a misdemeanor.



Legal Notice or Notice of Violation



Request for a Compliance Review



Request for an Administrative Hearing



Notice to Appear in Court



Kern County Ordinance Code 8.04.160: If the Director of Public Health Services determines that applicable laws have not been complied with, he may suspend or revoke the permit after first issuing a notice setting forth the acts or omissions with which the permittee is charge and informing him of his right to a hearing.



California Public Resource Code, Section 16053: Up to \$5,000 in civil penalties for the first violation, and up to \$10,000 for second or subsequent violations.



Kern County Ordinance Code 8.04.130: the Director of Public Health Services is authorized to charge for services rendered by the personnel of the Environmental Health Division, which are necessary to the performance of their duties as required by law. These charges are in addition to the health permit and fee(s) associated with the sewage pumping vehicle(s), grease pumping vehicle(s) and/or toilet rental business.